

VELUX®

KFX 210/211/212/213/214
KFC 210/220
BD-SC001-XX/BD-SC002-XX



**Instructions for VELUX control
system for smoke ventilation**

ENGLISH



VAS 453812-2023-05

Contents

Important information	4-7
Contents of packaging	8-9
Overview of printed circuit board	10-11
Break-glass point KFK 100	12
Smoke detector KFA 100	13
Rain sensor KLA 200	14
Ventilation switch KFK 200	15
Motor terminals	16
Wiring	17
Setting of switches	18-19
Operation of and signals from control unit	20
Back-up batteries	21
Mains connection	22
Status and error indication in control system	23-25
Connected control units	26-31
- Transmit alarm from one control unit KFC to another	26
- Receive and transmit error indications from one control unit KFC to another	27
- Ventilation switch	28
- Rain sensor	29
- Receive alarm from a primary, external control system	30
- Transmit alarms or error indications to other external equipment	31
Replacement of frame in control unit	32
Technical data	33

Important information



Please read instructions carefully before proceeding and keep them for future reference behind the battery holder inside the control unit.

Safety

- Control system for smoke ventilation KFX 210/211/212/213/214 and control unit for smoke ventilation KFC 210/220 can be used by persons (aged 8 years and above) with sufficient experience and knowledge if they have been given instruction concerning safe use and understand the hazards involved. Cleaning and user maintenance must not be made by unsupervised children.
- Children must not play with the control system.
- The installer must instruct the owner in the function of the control system including resetting of alarms and position of data plate and instructions.
- The data plate is placed in the control unit.
- When resetting alarms, be sure not to touch conductive parts and make sure that no body parts can get caught in the window when reactivated.
- **WARNING!** Make sure to use ESD protection when touching the printed circuit board for example during installation and service.

Important information



Product

- The control system has been designed for use with genuine VELUX products. Connection to other products may cause damage or malfunction.
- The control system is in conformity with the Low Voltage Directive and the EMC Directive for use in household, trade, industry and light industry.
- When installed, the control system complies with protection degree IP 42.
- The control system can operate smoke ventilation windows with a total power consumption of 10 A (KFC 210) and 2 x 10 A (KFC 220) respectively.
- The packaging must be disposed of in accordance with national regulations.
-  The product, including batteries if any, is regarded as electrical and electronic equipment and contains hazardous materials, components and substances. The crossed out wheeled bin symbolises that electrical and electronic equipment waste must not be disposed of together with household waste. It must be collected separately at recycling stations or other collection sites or retrieved directly from households to increase the possibilities of recycling, reuse and utilisation of electrical and electronic equipment waste. By sorting electrical and electronic equipment waste with this symbol, you contribute to reducing the volume of incinerated or buried waste and to reducing any negative impact on human health and the environment. Further information can be obtained from the local municipality's technical administration or from your VELUX sales company.
- If batteries can be removed, product and batteries must be disposed of separately.

Installation

- Installation must be carried out by a certified person in accordance with current national regulations.
- The control system must be connected directly to the mains supply in accordance with national regulations. Ensure that the mains supply cannot be disconnected unintentionally. It is recommended that disconnection is only possible using the mains switch or a key switch. At least one of these means for disconnection must be incorporated in the fixed wiring in accordance with national wiring requirements.
- The control system incorporates an earth connection for functional purposes only.

Maintenance and service

- Disconnect mains supply and back-up batteries before carrying out any maintenance or service work to the control system and ensure that they cannot be reconnected unintentionally.
- The control system must be tested after installation, service work and alterations to the system. It must be inspected by qualified personnel at least once a year. Tests and inspections must be documented in accordance with national regulations.
- At the yearly inspection, the connected products must be checked according to their instructions.
- The printed circuit board monitors the time between inspection periods. If more than 15 months have passed since the last inspection, the yellow light-emitting diode is on and an acoustic alarm sounds.
- The batteries must be checked at the yearly inspection. We recommend that the batteries are replaced at least every four years.
- If you have any technical questions, please contact your VELUX sales company, see telephone list or www.velux.com.

CE Declaration of Conformity

We herewith declare that the VELUX control system for smoke ventilation

KFX 210 (control unit 3FC F21 (model BD-SC001), smoke detector KFA 100/3FA F01 and break-glass point KFK 100/3FK F00),

KFX 211 (control unit 3FC F21 (model BD-SC001), smoke detector KFA 100/3FA F01 and break-glass point KFK 101/3FK F01),

KFX 212 (control unit 3FC F21 (model BD-SC001), smoke detector KFA 100/3FA F01 and break-glass point KFK 102/3FK F02),

KFX 213 (control unit 3FC F21 (model BD-SC001), smoke detector KFA 100/3FA F01 and break-glass point KFK 103/3FK F03),

KFX 214 (control unit 3FC F21 (model BD-SC001), smoke detector KFA 100/3FA F01 and break-glass point KFK 104/3FK F04) and

VELUX control units for smoke ventilation KFC 210 (3FC F21 (model BD-SC001)) and KFC 220 (3FC F22 (model BD-SC002-01))

- are in conformity with the Low Voltage Directive 2014/35/EU, the EMC Directive 2014/30/EU and the RoHS Directive 2011/65/EU,
- have been manufactured in accordance with the harmonised standards EN 61000-3-2(2014), EN 61000-3-3(2013), EN 55014-1(2006)+A1(2009)+A2(2011), EN 50130-4(2011), EN 60335-1(2012)+A11(2014) and EN 62233(2008) and
- have been assessed in accordance with the harmonised standard EN 50581(2012).

When one of the above-mentioned VELUX control systems or VELUX control units is connected to a VELUX smoke ventilation window GGL -K- ----40, GGU -K- ----40 or CSP, the total system is to be considered as a machine, which is not to be put into service until it has been installed according to instructions and requirements.

The total system then complies with the essential requirements of the Directives 2014/35/EU, 2014/30/EU and 2006/42/EC of the European Parliament and Council.

The control systems and control units also comply with the Construction Products Regulation (EU) No. 305/2011. For Declaration of Performance, please go to www.velux.com/ce-ukca.

VELUX A/S:
(Jens Aksel Thomsen, Senior Certification Specialist)

Ådalsvej 99, DK-2970 Hørsholm. 11-11-2019

DoC 940402-02

UK CA Declaration of Conformity

We herewith declare that the VELUX control system for smoke ventilation

KFX 210 (control unit 3FC F21 (model BD-SC001), smoke detector KFA 100/3FA F01 and break-glass point KFK 100/3FK F00),

KFX 211 (control unit 3FC F21 (model BD-SC001), smoke detector KFA 100/3FA F01 and break-glass point KFK 101/3FK F01),

KFX 212 (control unit 3FC F21 (model BD-SC001), smoke detector KFA 100/3FA F01 and break-glass point KFK 102/3FK F02),

KFX 213 (control unit 3FC F21 (model BD-SC001), smoke detector KFA 100/3FA F01 and break-glass point KFK 103/3FK F03),

KFX 214 (control unit 3FC F21 (model BD-SC001), smoke detector KFA 100/3FA F01 and break-glass point KFK 104/3FK F04) and

VELUX control units for smoke ventilation KFC 210 (3FC F21 (model BD-SC001)) and KFC 220 (3FC F22 (model BD-SC002-01))

- are in conformity with the Electromagnetic Compatibility Regulations 2016 (S.I. 2016/1091), the Electrical Equipment (Safety) Regulations 2016 (S.I. 2016/1101) and the Restriction of the Use of Certain Hazardous Substances in Electrical and Electronic Equipment Regulations 2012 (S.I. 2012/3032),
- have been manufactured in accordance with the UK designated standards EN 61000-3-2(2014), EN 61000-3-3(2013), EN 55014-1(2006)+A1(2009)+A2(2011), EN 50130-4(2011), EN 60335-1(2012)+A11(2014) and EN 62233(2008) and
- have been assessed in accordance with the UK designated standard EN 50581(2012).

When one of the above-mentioned VELUX control systems or VELUX control units is connected to a VELUX smoke ventilation window GGL -K- ----40, GGU -K- ----40 or CSP, the total system is to be considered as a machine, which is not to be put into service until it has been installed according to instructions and requirements.

The total system then complies with the essential requirements of the Supply of Machinery (Safety) Regulations 2008 (S.I. 2008/1597), Electrical Equipment (Safety) Regulations 2016 (S.I. 2016/1101) and Electromagnetic Compatibility Regulations 2016 (S.I. 2016/1091).

The control systems and control units also complies with the Construction Products Regulation 2019 (S.I. 2019/465 and 2020/1359). For Declaration of Performance, please go to www.velux.com/ce-ukca.

On behalf of our local representative:

VELUX Company Ltd.

Woodside Way, Glenrothes East, Fife, KY7 4ND

United Kingdom

VELUX A/S:.....

(Jens Aksel Thomsen, Senior Certification Specialist)

Ådalsvej 99, DK-2970 Hørsholm..... 11-11-2021.....

DoC 940402-02

Contents of packaging

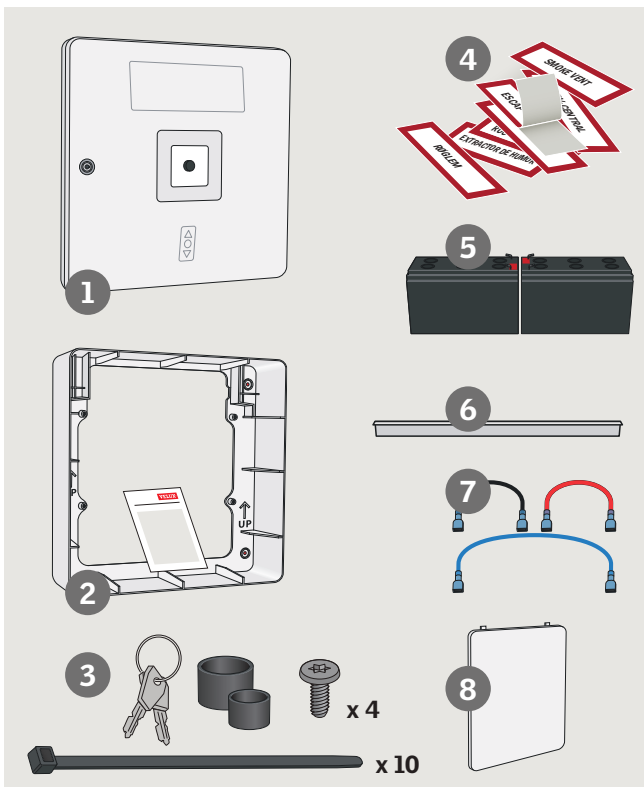

1 Control unit for smoke ventilation KFC 210 or KFC 220 – see type designation in the control unit.

2 Frame with instructions

3 Keys, rubber bushes, screws and cable ties

4 Labels

5 Back-up batteries

6 Battery holder

7 Cables for batteries

8 Blank lid

9 Break-glass point (KFK 100-104*)

10 Smoke detector (KFA 100*)

11 Coloured frame*)

*) Is delivered depending on type of control system.

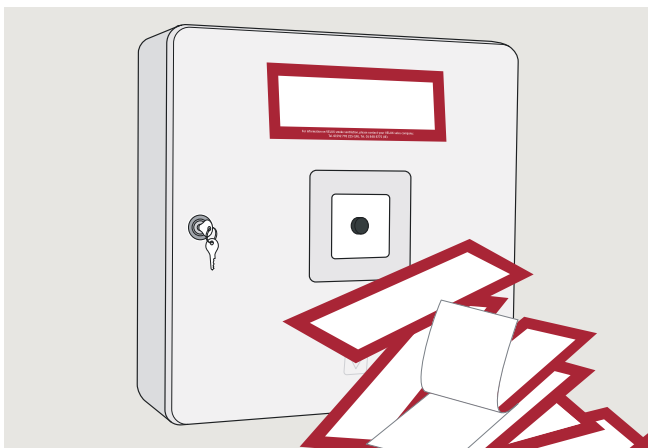

Stick the supplied label "SMOKE VENTILATION" onto the indicated area on the control unit.

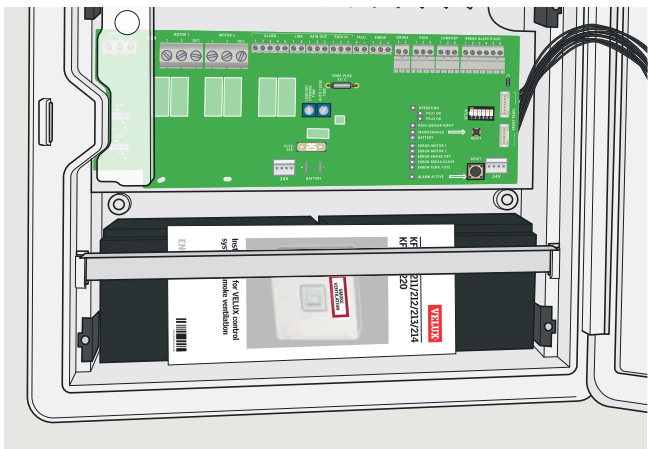

Keep the instructions behind the battery holder in the control unit.

Overview of printed circuit board

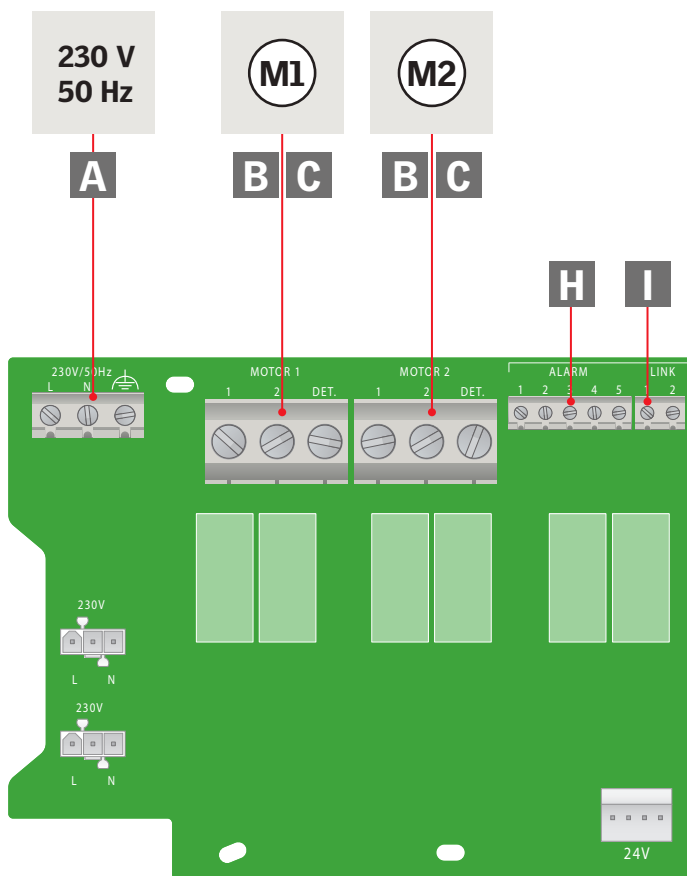

A	Mains connection	22	F	Ventilation switch	15
B	Motor 1 + Motor 2	16	G	Break-glass point	12
C	Wiring	17	H	Alarm signals	26, 30-31
D	Smoke detector	13	I	Link	27
E	Rain sensor	14	J	Rain signal - output	29

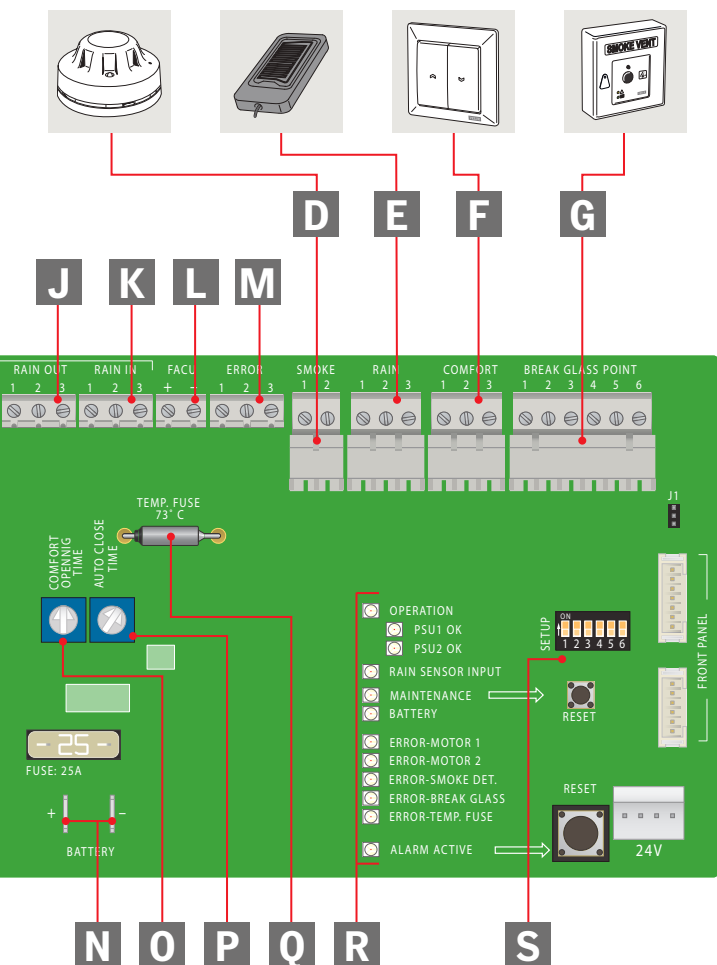

K	Rain signal - input	29	P	Auto close time	15
L	FACU terminals	26, 30	Q	Temperature fuse	25
M	Error indication	31	R	Status indications	23-25
N	Batteries	21	S	Setting of switches	18-19
O	Comfort opening time	15			

Break-glass point KFK 100

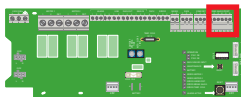

Up to 10 break-glass points can be connected to each control system.

Installation

Break-glass points KFK 100/101/102/103/104 are surface-mounted and should be connected in accordance with current national legislation. The installation surface must be smooth and level.

Connection

The break-glass point is connected to the control unit by means of a 6-core cable with a minimum cross-section of 0.5 mm². This cable can be up to 100 m long.

Break-glass points KFK 100/101/102/103/104 must be installed in continuous single line connections to ensure that the complete line from the control unit to the last break-glass point is monitored. Individual connection to more than one break-glass point does not allow for monitoring.

The first additional break-glass point must be connected to the terminals in the control unit. When connecting, lead cable through the rubber membrane and fasten with cable tie.

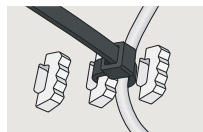
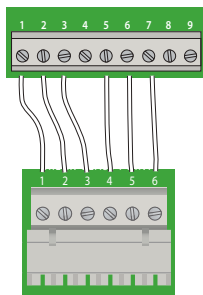

Terminal module J1 (jumper)

Terminal module J1 in the control unit must be moved to the last or only break-glass point – ie to the break-glass point placed farthest away from the control unit **[a]**.

Note: If there are no break-glass points in the system, the terminal module in the control unit must be moved from the middle and lowest pin to the top and middle pin **[b]**.

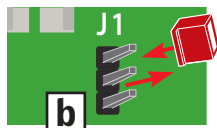
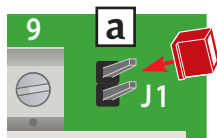

Colour of frame for break-glass point in control unit

The white frame can be replaced by the coloured frame supplied (applies to KFX 211, 212, 213 and 214 and KFC 210 and 220). See page 32.



Smoke detector KFA 100

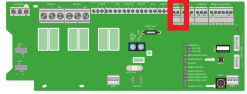
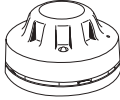

Up to 10 smoke detectors can be connected to each control system.

Installation

Smoke detector KFA 100 should always be fitted on the ceiling in accordance with current national legislation. After fitting the base, the smoke detector can be snapped into place. Position dust cover over the smoke detector until it is ready for operation.

Connection

The smoke detector is connected to the control unit by means of a 2-core cable with a minimum cross-section of 0.5 mm². This cable can be up to 100 m long.

Smoke detectors KFA 100 must be installed in continuous single line connections to ensure that the complete line from the control unit to the last detector is monitored. Individual connection to more than one smoke detector does not allow for monitoring.

When connecting, lead cable through the rubber membrane and fasten with cable tie.

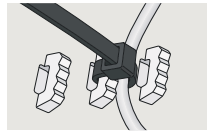
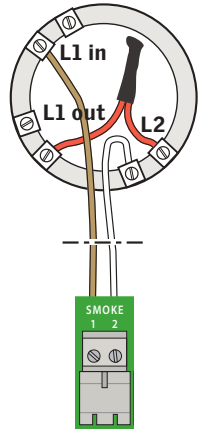

Terminal module

The terminal module in the control unit must be moved to the last or only smoke detector – ie to the smoke detector placed farthest away from the control unit.

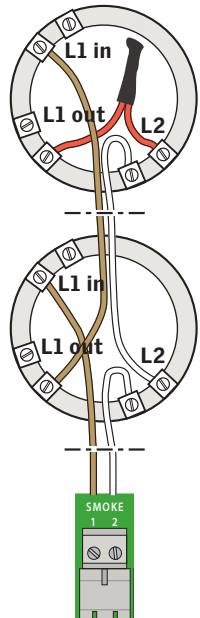

Rain sensor KLA 200

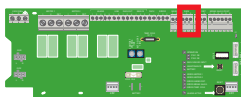

The product can be purchased separately.

Note: When fitting rain sensor KLA 200, use the instructions supplied with the sensor.

Connection

The rain sensor is connected to the control unit by means of a 3-core cable with a minimum cross-section of 0.5 mm². This cable can be up to 100 m long.

Note: If the rain sensor has been activated, ie has closed the window due to rain, it will take at least 2 minutes before the comfort ventilation can be activated again.

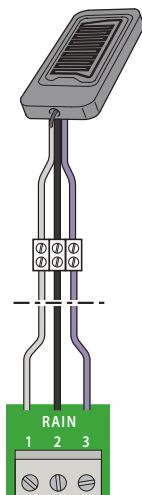

When connecting, lead cable through the rubber membrane and fasten with cable tie.

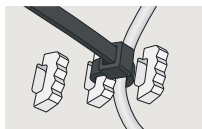

Ventilation switch KFK 200

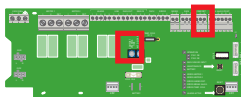

Up to 10 ventilation switches can be connected to each control system.

The product can be purchased separately.

Connection

The ventilation switch is connected to the control unit by means of a 3-core cable with a minimum cross-section of 0.5 mm². This cable can be up to 100 m long.

Output 1: Open

Output 2: Close

Output 3: Common

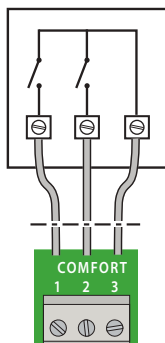
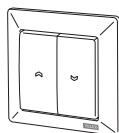

When connecting, lead cable through the rubber membrane and fasten with cable tie.

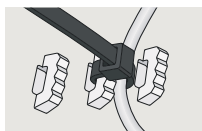

Setting of timers

COMFORT OPENING TIME

The time it takes for the window to open (in seconds) can be set when the window is opened for comfort ventilation purposes (factory setting is about 12 seconds).

Note: The window must not be opened more than 20 cm.

Min duration: 5 seconds

Max duration: 60 seconds

AUTO CLOSE TIME

Automatic closing of windows opened for comfort ventilation purposes can also be set. This function is only active if switch 4 is set in position ON (see page 19).

Min opening time: 2 minutes

Max opening time: 60 minutes

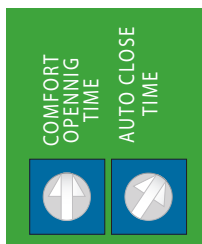

Min Max

Motor terminals

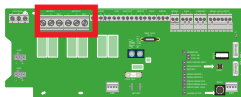

Each terminal is intended for 24 V DC and max 10 A.

Control unit KFC 210 (10 A)

In this example, only motor terminal **1** is active.

Max **4** smoke ventilation windows

GGL/GGU -K-- ----40

or

1 smoke ventilation window **CSP** can be connected to the control unit.

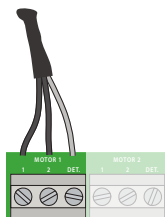

Control unit KFC 220 (2 x 10 A)

In this example, both motor terminals **1** and **2** are active.

Max **8** smoke ventilation windows

GGL/GGU -K-- ----40

(max **4** windows per motor terminal)

or

2 smoke ventilation windows **CSP** can be connected to the control unit.

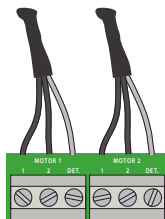

Terminal module

To ensure cable monitoring, the terminal module in the control unit must be moved to the last connection between smoke ventilation windows GGL/GGU -K-- ----40 or CSP and the cables from the control unit.

Note: In case motors operate in the wrong direction, transpose the **two** motor cables in the terminal.

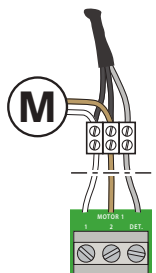
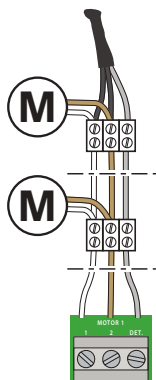

Wiring

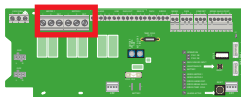

Electrical cables should be drawn according to regulations by qualified personnel. The control system and its cables should be installed in compliance with current national legislation and the requirements of local authorities.

Maximum cable length/prescribed cross-sectional size of cables

The maximum allowed cable lengths between control unit and motor and the prescribed cross-sectional sizes of the cables are given in the table below. The cable must be protected according to national/European standards.

Calculation of maximum cable length: $56 \times A/I$

A is cable cross-section and **I** is max motor current in total.

Allowed maximum voltage drop in the cable: 2 V

Operation current: The total of all motor currents.

Cable cross-section per motor terminal for smoke ventilation window
GGL/GGU -K-- ----40

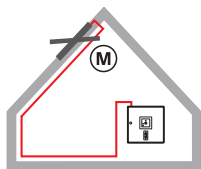

Cable cross-section	Max. cable length for number of motors (M *)			
	M 1	M 2	M 3	M 4
3 x 1.5 mm ²	33 m	16 m	11 m	8 m
*) 5 x 1.5 mm ²	67 m	33 m	22 m	16 m
3 x 2.5 mm ²	56 m	28 m	18 m	14 m
*) 5 x 2.5 mm ²	112 m	56 m	37 m	28 m
3 x 4 mm ²	89 m	44 m	29 m	22 m
3 x 6 mm ²	134 m	67 m	44 m	33 m

*) 2 x 2 conductors in parallel

Cable cross-section per motor terminal for smoke ventilation window
CSP

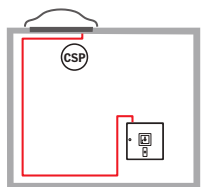

Cable cross-section	Max. cable length *)
3 x 1.5 mm ²	8 m
*) 5 x 1.5 mm ²	16 m
3 x 2.5 mm ²	14 m
*) 5 x 2.5 mm ²	28 m
3 x 4 mm ²	22 m
3 x 6 mm ²	33 m

*) 2 x 2 conductors in parallel

Only one smoke ventilation window CSP per motor terminal

Setting of switches

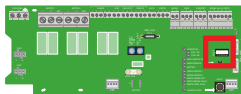

Remove thin foil before setting the switches, if necessary (1-6).

Switch 1

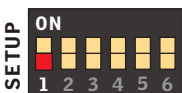

Cable errors are indicated by the yellow light-emitting diode that flashes on and off and an acoustic alarm from control unit and connected break-glass points.
(Factory setting).

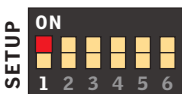

Cable errors are indicated by the red light-emitting diode and an acoustic alarm from control unit and connected break-glass points, and windows open.

Switch 2

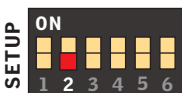

No external fire alarm is connected to FACU terminal (FACU = Fire Alarm Control Unit).
(Factory setting).

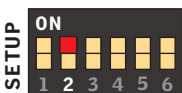

An external fire alarm is connected to FACU terminal and the cable connection is monitored.

Switch 3

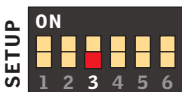

If an alarm is activated via a smoke detector, the window opens fully.
(Factory setting).

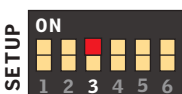

If an alarm is activated via a smoke detector, all windows that are open (in comfort ventilation position) close.

Note: If an alarm is activated via a break-glass point, all windows open.

Setting of switches

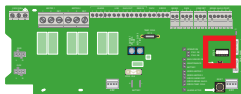

Switch 4

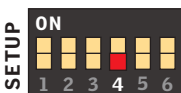

Automatic, time controlled closing of comfort ventilation is off.
(Factory setting).

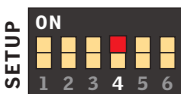

Automatic, time controlled closing of comfort ventilation is on.
The time is set by means of the timer "AUTO CLOSE TIME", see section *Ventilation switch KFK 200*.

Switch 5



Battery monitoring is on. (Factory setting).
Note: When the battery is low, the light-emitting diode flashes on and off. If the service technician decides to turn off the switch, the battery monitoring is also off.

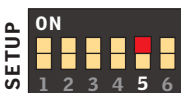

Battery monitoring is off.

Switch 6



N/A



N/A

Operation of and signals from control unit

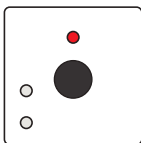
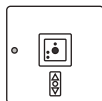

Break-glass point

In case of fire: Break the glass cover and press the black button. All windows connected to the control system open. The red light-emitting diode over the black button in the control unit is on and an acoustic alarm sounds. All ventilation and rain sensor functions are disengaged.

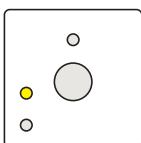

Yellow light-emitting diode

In case of system errors, the yellow light-emitting diode flashes on and off and an acoustic alarm sounds. Error indication occurs, if cables for motors, break-glass points or smoke detectors are interrupted or short-circuited, or if the batteries are defective. If additional break-glass points are connected, the corresponding diodes in these will also flash on and off and an acoustic alarm sounds.

Additional information on error causes can be seen on the printed circuit board in the control unit. See section *Status and error indications in control system*.

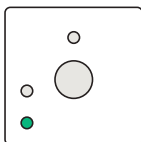

Green light-emitting diode

Under normal operation conditions, the green light-emitting diode in the control unit is on. All other light-emitting diodes are off. If additional break-glass points are connected, the corresponding diodes in these will also be on.

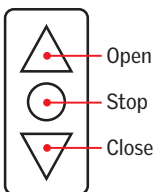

Operating buttons for comfort ventilation

A short press of the top ventilation button opens the window to max comfort ventilation position.

A short press of the bottom ventilation button closes the window completely.

By pressing and holding the top or bottom ventilation button, the window opens/closes until the button is released.

By pressing the stop button or by pressing the top and bottom buttons simultaneously, the window stops.

By means of the timers in the control unit, it is possible to set the duration of the opening when the window is opened for comfort ventilation and set automatic closing of the window. See section *Ventilation switch KFK 200*.

Note: If a rain sensor is connected, the comfort ventilation function will automatically be blocked if rain is detected.

Back-up batteries

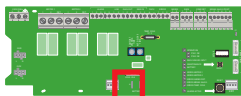

The control unit has batteries that ensure emergency power supply for 72 hours in case of power failure. Therefore, if there is a fire alarm within these 72 hours, the windows will still be able to open.

Note: The batteries must be checked at the yearly inspection. We recommend that the batteries are replaced at least every four years. Note the replacement date.

In case of power failure, the comfort ventilation is interrupted automatically, and all windows close after 2 minutes. Comfort ventilation is not possible until the mains connection has been re-established.

The printed circuit board monitors the status of the back-up batteries. If the control unit is being supplied with power from the back-up batteries, the yellow light-emitting diode flashes on and off showing that the 230 V mains supply is interrupted.

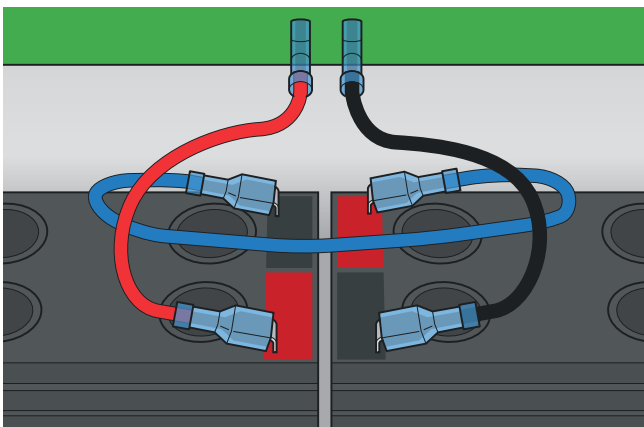

Install battery holder.

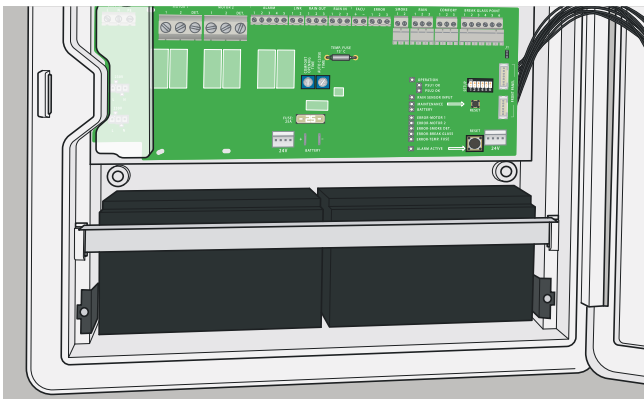

Mains connection

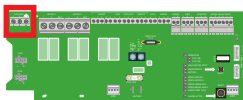

Remove cover plate over the terminals and connect the cable.

⚠ Take all necessary actions to comply with current local requirements (contact a qualified electrician, if necessary).

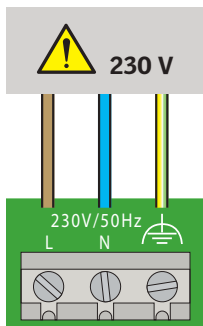

Lead cable as shown and fasten it in cable gland. For optimum fixing, the rubber bush can be replaced by one of the rubber bushes supplied.

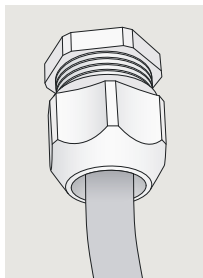

Status and error indication in control system

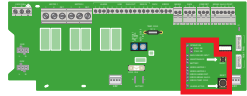

OPERATION

The printed circuit board monitors the present status of the control system.

Normal operation condition of the control unit is indicated with a green light-emitting diode.

PSU1 OK

The printed circuit board monitors the present status of the power supply for motor terminal 1 (used in control units KFC 210 and KFC 220). The light-emitting diode indicates that the motor terminal is being supplied with power from the integrated power supply.

If the 230 V mains supply to the control unit is interrupted, the printed circuit board automatically switches to battery supply and the diode is turned off.

PSU2 OK

The printed circuit board monitors the present status of the power supply for motor terminal 2 (used in control units KFC 220 only).

The light-emitting diode indicates that the motor terminal is being supplied with power from the integrated power supply.

If the 230 V mains supply to the control unit is interrupted, the printed circuit board automatically switches to battery supply and the diode is turned off.

RAIN SENSOR - INPUT

The printed circuit board monitors the present status of the rain sensor.

If the connected rain sensor detects rain, the yellow light-emitting diode is on and any window opened for comfort ventilation closes. When the rain has stopped, the yellow light-emitting diode is turned off and the window can again be opened for comfort ventilation after two minutes.

MAINTENANCE

The printed circuit board monitors the time between inspection periods. If more than 15 months have passed since the last inspection, the yellow light-emitting diode is on and an acoustic alarm sounds. During the inspection, the system is reset by pressing the button at the right  for at least 5 seconds. After this, 15 months will pass before the light-emitting diode comes on again, if the service time is exceeded. Exceeded service intervals are also error indicated with a yellow light-emitting diode in the integrated break-glass point and possible additional break-glass points and an acoustic alarm.

Status and error indication in control system

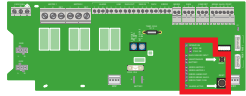

BATTERY

The printed circuit board monitors the status of the back-up batteries. If the control unit is supplied with power from the back-up batteries, the yellow light-emitting diode flashes on and off showing that the 230 V mains supply is interrupted.

If the batteries are not connected or are defective, the yellow light-emitting diode is on permanently showing that the batteries should be connected or replaced. This is also the case if the 25 A fuse is defective. In all three cases, an acoustic alarm sounds.

Note: If the back-up batteries are heavily discharged, the yellow light-emitting diode flashes on and off and the green OPERATION diode on the circuit board is not on until the batteries are fully charged.

ERROR - MOTOR 1

The printed circuit board monitors for defects in the cable from motor terminal 1 (used in control units KFC 210 and KFC 220).

If the cable is interrupted, the yellow light-emitting diode flashes on and off. If the cable is short-circuited, the yellow light-emitting diode is on permanently.

The error is also indicated in the integrated break-glass point and possible additional break-glass points.

ERROR - MOTOR 2

The printed circuit board monitors for defects in the cable from motor terminal 2 (used in control unit KFC 220 only).

If the cable is interrupted, the yellow light-emitting diode flashes on and off. If the cable is short-circuited, the yellow light-emitting diode is on permanently.

The error is also indicated in the integrated break-glass point and possible additional break-glass points.

ERROR - SMOKE DETECTOR

The printed circuit board monitors for defects in the cable to any smoke detectors that are connected.

If the cable to the connected smoke detector(s) is interrupted, the yellow light-emitting diode flashes on and off. If the cable is short-circuited, the yellow light-emitting diode is on permanently.

The error is also indicated in the integrated break-glass point and possible additional break-glass points.

Status and error indication in control system

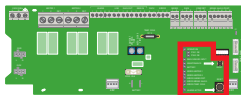

⊙ ERROR - BREAK-GLASS POINT

The printed circuit board monitors for defects in the cable to any break-glass points that are connected.

If the cable to the connected break-glass point(s) is interrupted, the yellow light-emitting diode flashes on and off. If the cable is short-circuited, the yellow light-emitting diode is on permanently.

The error is also indicated in the integrated break-glass point and possible additional break-glass points.

Note: If there are no break-glass points in the system, the terminal module in the control unit must be moved from the middle and lowest pin to the top and middle pin (see page 12).

⊙ ERROR - TEMP. FUSE

The printed circuit board monitors the temperature in the control unit.

If the temperature in the control unit rises above 70 °C, the temperature fuse on the printed circuit board is activated and all connected windows open for smoke ventilation. The yellow light-emitting diode is on permanently until the printed circuit board has been replaced. After replacing the printed circuit board, the installation must be service tested thoroughly to ensure that the system works correctly.

The error is also indicated in the integrated break-glass point and possible additional break-glass points.

⊙ ALARM - ACTIVE

The red light-emitting diode on the front of the control unit is on permanently when the smoke ventilation function has been activated (from break-glass point, smoke detector or external fire alarm).

The alarm can be reset by pressing the button ⇨ ⊙ at the right. After this, the light-emitting diode on the printed circuit board and in all break-glass points are turned off.

⊙ ERROR - COMFORT VENTILATION

After an alarm or a power failure, it will take at least 2 minutes before the comfort ventilation can be activated again.

Connected control units

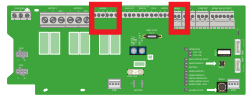

Transmit alarm from one KFC control unit to another

In installations with several connected control units, all smoke detectors and additional break-glass points must be connected to control unit 1 only (see below).

In the other control units, the glass plate on the front face must be replaced by the blank lid provided. In case of an alarm, an acoustic alarm sounds from all control units and all windows open.

If an alarm is activated, the principal control unit must be reset first. Subsequently, the other control units must be reset one by one.

Connection is established from the ALARM terminal in the principal control unit (control unit 1) to the FACU terminal in the next control unit. If more than two control units are linked, connect from the ALARM terminal in control unit 2 to the FACU terminal in control unit 3 etc.

Note: In control unit 2 and possible additional control units, switch 2 is set in position ON.

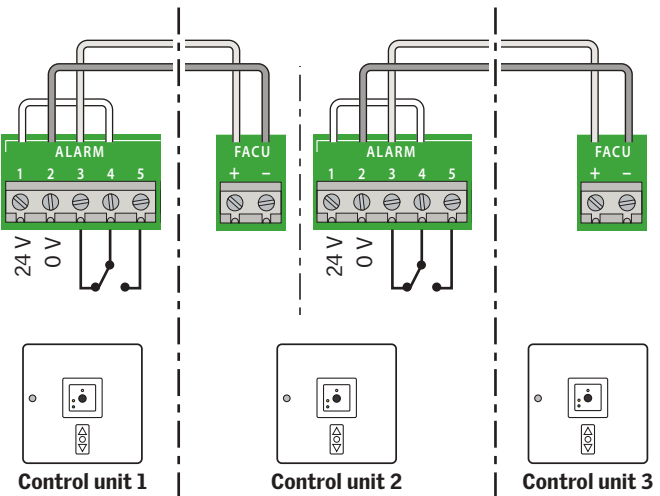

Connected control units

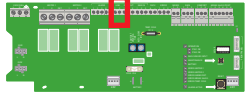

Receive and transmit error indications from one control unit KFC to another

Up to 10 control units can be connected.

In the connection shown below, error indications in one control unit will be registered and shown in all control units. Indication of the specific error can be seen on the printed circuit board of the control unit where the error has occurred.

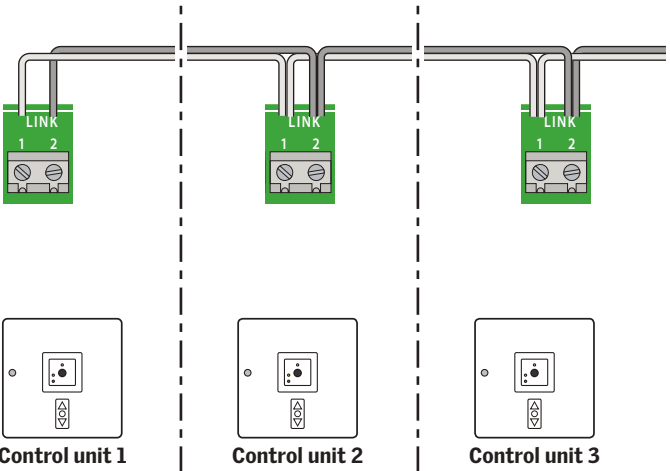

Connected control units

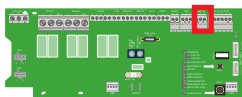

Ventilation switch

Up to 10 ventilation switches KFK 200 can be connected to each control system. Up to 10 control systems can be connected.

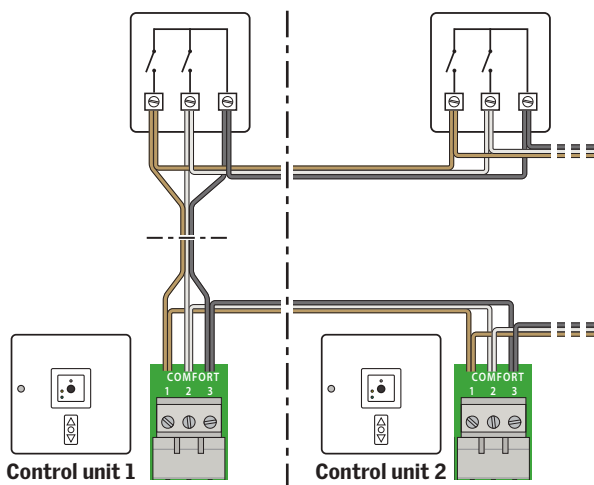

Note: Do **not** connect the control systems if you would like a local ventilation switch.

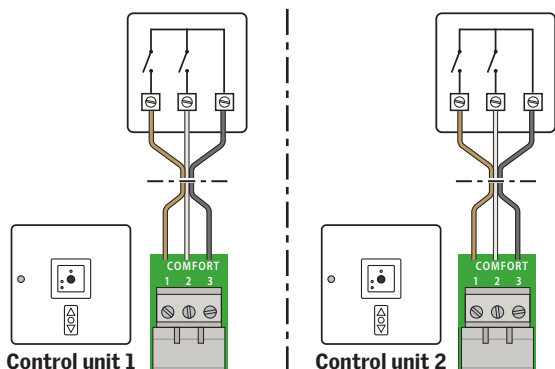

Connected control units

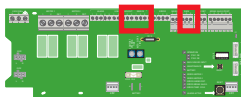

Rain sensor

The product can be purchased separately.

Connection

The rain sensor is connected to the control system by means of a 3-core cable with a minimum cross-section of 0.5 mm². This cable can be up to 100 m long.

Note: If the rain sensor has been activated, it will take at least 2 minutes before the comfort ventilation can be activated again.

The example below shows a cable connection with several control systems but only one rain sensor.

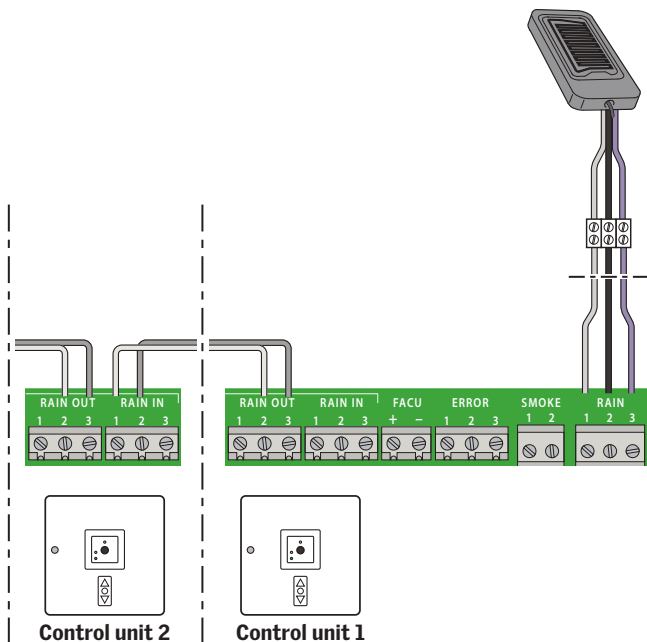

Connected control units

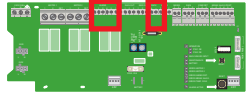

Receive alarm from a primary, external control system

In installations with several connected control systems, all smoke detectors and additional break-glass points must be connected to the primary, external control system according to the instructions supplied with them. In this installation, control unit KFC is controlled by the primary, external control system and the smoke ventilation function will be activated when an alarm is received from the primary, external control system.

Connection is established by placing the cable from the primary control system in the FACU-terminal in control unit KFC.

Note: Set switch 2 in position ON in the control unit.

If an alarm is activated from an external control system (FACU) and sent to several connected control units, all control units are activated and all connected windows are opened.

When the alarm is reset in the external control system (FACU), all connected control units are reset and all connected windows are closed.

To ensure monitoring of cables, one of the following descriptions must be followed:

- a** If the external control system has a 24 V DC or 48 V DC outlet which is interrupted in case of fire,
- b** If the external control system has one potential-free relay outlet only which is interrupted in case of fire,

monitoring of cables is obtained by connecting 24 V DC or 48 V DC through the relay.

Note: Do not overload the 24 V outlet with other additional connections.

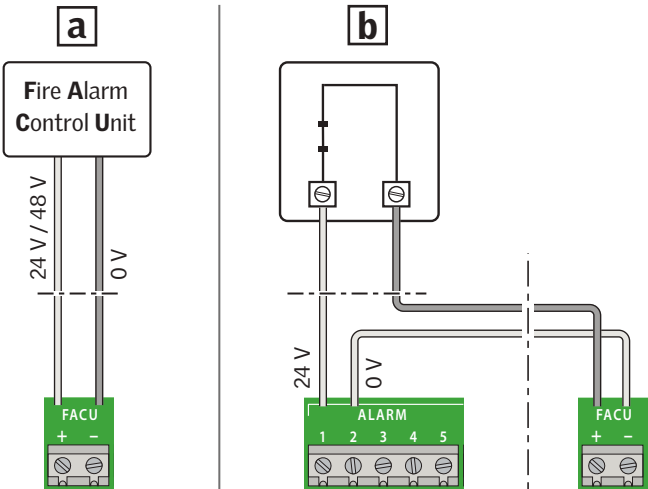

Connected control units

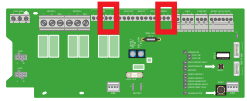

Transmit alarms or error indications to other external equipment

It is possible to transmit an alarm or an error indication to other external equipment.

- a** An alarm will be transmitted from the ALARM terminal where a potential-free relay switches in case of alarm.
- b** Error indications will be transmitted from the ERROR terminal where a potential-free relay switches in case of alarm.

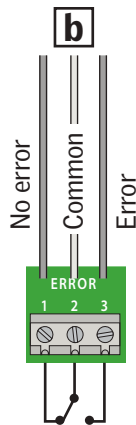
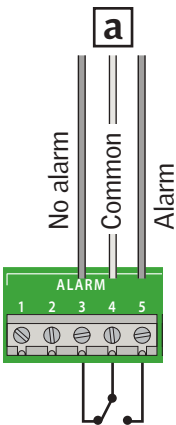

Replacement of frame in control unit

The white frame of the control unit can be replaced by the coloured frame supplied (applies to KFX 211, 212, 213 and 214 only).

Remove white frame as shown.

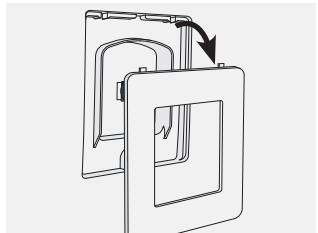
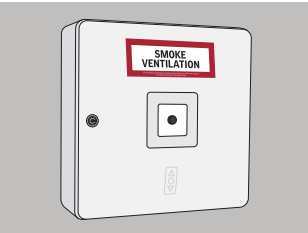
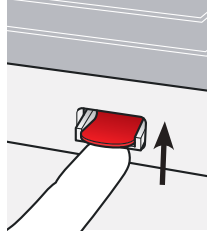
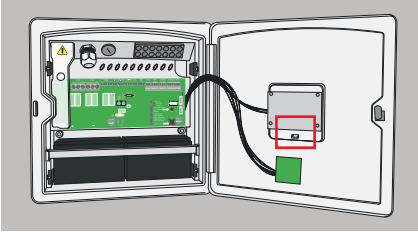

Place glass from the white frame in the coloured frame.

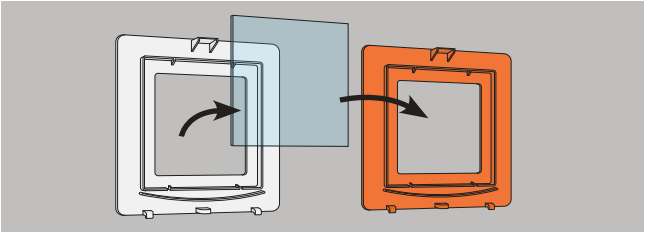

Fit the coloured frame.

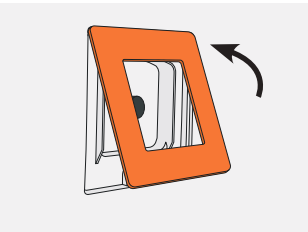

Technical data

Primary voltage: 230 V AC/50 Hz ($\pm 10\%$)

Power consumption:

- KFC 210 max 250 W
- KFC 220 max 500 W

Secondary voltage: 24 V DC (21-26.4 V DC)

Ripple voltage: max 2 Vpp

Load max:

- 10 A (KFC 210)
- 2 x 10 A (KFC 220)
- ED 10 % per 10 minutes

Alarm and error relays: Contact rating 24 V DC, 1 A

Battery backup:

- 2 x 12 V/7.2 A h
- Expected battery lifetime: 4 years

Interruption time between mains supply and batteries: Max 2.5 sec

Fuses:

- Battery fuse 25 A
- Thermo fuse 73 °C

Status LED in break-glass point:

- Green light, system OK
- Yellow light, error. For details, see pages 12 and 20
- Red light, alarm active

Environmental class: 1

Operational temperature: -5 °C to +40 °C

IP rating: IP 42

Cabinet size for wall mounting: 398 x 393 x 127 mm (W x H x D)

Mounting hole size for flush mounting:

- 355 (± 5) x 355 (± 5) x 100 mm (W x H x D)
- Wall thickness min 10 mm

Weight KFC 210:

- Without batteries: 3.1 kg
- With batteries: 8.0 kg

Weight KFC 220:

- Without batteries: 3.7 kg
- With batteries: 8.6 kg

Cabinet colour: RAL 9016, white

Maintenance: Once a year or according to local requirements (service timer 15 months)

AR: VELUX Export (VELUX A/S) + 45 4516 7885	IT: VELUX Italia s.p.a. 045/6173666
AT: VELUX Österreich GmbH 02245/32 3 50	JP: VELUX-Japan Ltd. 0570-00-8141
AU: VELUX Australia Pty. Ltd. 1300 859 856	KR: VELUX Export (VELUX A/S) + 45 4516 7885
BA: VELUX Bosna i Hercegovina d.o.o. 033/626 493, 626 494	LT: VELUX Lietuva, UAB (85) 270 91 01
BE: VELUX Belgium (010) 42.09.09	LV: VELUX Latvia SIA 67 27 77 33
BG: БЕЛУКС България ЕООД 02/955 99 30	NL: VELUX Nederland B.V. 030 - 6 629 629
CA: VELUX Canada Inc. 1 800 88-VELUX (888-3589)	NO: VELUX Norge AS 22 51 06 00
CH: VELUX Schweiz AG 062 289 44 45	NZ: VELUX New Zealand Ltd. 0800 650 445
CL: VELUX Export (VELUX A/S) + 45 4516 7885	PL: VELUX Polska Sp. z o.o. (022) 33 77 000 / 33 77 070
CN: VELUX (CHINA) CO. LTD. 0316-607 27 27	PT: VELUX Portugal, Lda 21 880 00 60
CZ: VELUX Česká republika, s.r.o. 531 015 511	RO: VELUX România S.R.L. 0268-402740
DE: VELUX Deutschland GmbH 040 / 54 70 70	RS: VELUX Srbija d.o.o. 011 20 57 500
DK: VELUX Danmark A/S 45 16 45 16	SE: VELUX Svenska AB 042/20 83 80
EE: VELUX Eesti OÜ 621 7790	SI: VELUX Slovenija d.o.o. 01 724 68 68
ES: VELUX Spain, S.A.U. 91 509 71 00	SK: VELUX Slovensko, s.r.o. (02) 33 000 555
FI: VELUX Suomi Oy 0207 290 800	TR: VELUX Çatı Pencereleri Ticaret Limited Şirketi 0 216 302 54 10
FR: VELUX France 0806 80 15 15 Service gratuit + prix appel	UA: ТОВ "БЕЛЮКС Україна" (044) 2916070
GB: VELUX Company Ltd. 01592 778 225	US: VELUX America LLC 1-800-88-VELUX
HR: VELUX Hrvatska d.o.o. 01/5555 444	
HU: VELUX Magyarország Kft. (06/1) 436-0601	
IE: VELUX Company Ltd. 01 848 8775	